

UNI-T®

UT3550

Battery Tester User Manual



www.uni-trend.com.com

Preface

Thank you for purchasing this product. In order to use this product safely and correctly, please read this manual thoroughly, especially the safety notes.

Copyright Information

UNI-T products are protected by patent rights in China and other countries, including issued and pending patents. Uni-Trend reserves the rights to any product specification and pricing changes.

Uni-Trend Technology (China) Co., Ltd. all rights reserved. Trend reserves all rights. Information in this manual supersedes all previously published versions. No part of this manual may be copied, extracted or translated by any means without the prior permission of Uni-Trend.

UNI-T is the registered trademark of Uni-Trend Technology (China) Co., Ltd.

Warranty Service

The instrument has a warranty period of one year from the date of purchase. If the instrument is damaged due to improper operation by the user during the warranty period, the maintenance fee and the costs caused by the maintenance shall be borne by the user, and the instrument shall be maintained by the company for life.

If the original purchaser sells or transfers the product to a third party within one year from the date of purchase of the product, the warranty period of one year shall be from the date of the original purchase from UNI-T or an authorized UNI-T distributor. Power cords, accessories and fuses, etc. are not included in this warranty.

If the product is proved to be defective within the warranty period, UNI-T reserves the rights to either repair the defective product without charging of parts and labor, or exchange the defected product to a working equivalent product (determined by UNI-T). Replacement parts, modules and products may be brand new, or perform at the same specifications as brand new products. All original parts, modules, or products which were defective become the property of UNI-T.

The "customer" refers to the individual or entity that is declared in the guarantee. In order to obtain the warranty service, "customer" must inform the defects within the applicable warranty period to UNI-T, and perform appropriate arrangements for the warranty service.

The customer shall be responsible for packing and shipping the defective products to the individual or entity that is declared in the guarantee. In order to obtain the warranty service, customer must inform the defects within the applicable warranty period to UNI-T, and perform appropriate arrangements for the warranty service. The customer shall be responsible for packing and shipping the defective products to the designated maintenance center of UNI-T, pay the shipping cost, and provide a copy of the purchase receipt of the original purchaser. If the product is shipped domestically to the purchase receipt of the original purchaser. If the product is shipped to the location of the UNI-T service center, UNI-T shall pay the return shipping fee. If the product is sent to any other location, the customer shall be responsible for all shipping, duties, taxes, and any other expenses.

Guarantee Limit

This warranty shall not apply to any defects, malfunction or damages caused by accidental, machine parts' wear and tear, using outside the product's specifications, improper use, and improper or lacking of maintenance. UNI-T under the provisions of this warranty has no obligation to provide the following services:

- a) Any repair damage caused by the installation, repair, or maintenance of the product by non UNI-T service representatives;
- b) Any damage caused by improper use or connection to an incompatible device;
- c) Any damage or malfunction caused by the use of a power source not provided by UNI-T;
- d) Any maintenance on altered or integrated products (if such alteration or integration leads to an increase in time or difficulty of product maintenance).

This warranty is written by UNI-T for this product and it is used to substitute any other express or implied warranties. UNI-T and its distributors do not offer any implied warranties for merchantability or applicability purposes. For violation of this guarantee, UNI-T is responsible for the repair or replacement of defective products as the only and complete remedy available to customers. Regardless of whether UNI-T and its distributors are informed that any indirect, special, incidental, or consequential damage may occur, the UNI-T and its distributors shall not be responsible for any of these damages.

Safety Instructions

⚠ Warning ⚠ Danger:

To avoid possible electric shock and personal safety problem, please follow the instructions below.

Disclaimer	Please read the following safety information carefully before starting to use the instrument. Uni-Trend will not be responsible for the personal safety and property damage caused by the user's failure to comply with the following terms.
Instrument Grounding	To prevent the risk of electric shock, please connect the power ground wire.
DO NOT use the instrument in an explosive atmosphere	Do not use the instrument in flammable and explosive gas, steam or dusty environment. The use of any electronic equipment in such an environment is a risk to personal safety.
DO NOT the outer shell of the instrument	Non-professional maintenance personnel should not open the outer shell of the instrument to try to repair the instrument. The undischarged charge still exists for a period of time after the instrument is turned off, which may cause electric shock.
DO NOT use instruments that work abnormally	If the instrument does not work properly and its danger is unpredictable, please disconnect the power cord, do not use it, and do not try to repair it yourself.
DO NOT use the instrument beyond the way specified in this user manual	If it exceeds the range, the protective measures provided by the instrument will become invalid.
	Warning: For the instrument model UT3550, do not apply AC voltage and DC voltage exceeding 100V to the test terminal, otherwise the instrument will be damaged.

Waste Electrical and Electronic Equipment (WEEE) Directive 2002/96/EC



Must not be discarded in the trash can.

Table of Contents

Preface	2
Copyright Information	2
Warranty Service	2
Guarantee Limit	3
Safety Instructions	4
Table of Contents	5
1. Introduction	7
1.1 Product Introduction	7
1.2 Main Function	7
1.2.1 Calibration Function	7
1.2.2 Comparator Function (sorting)	7
1.3 System	8
1.3.1 Remote Control	8
1.4 Front Panel	8
1.4.1 Introduction of Front Panel	8
1.5 Interface Panel	9
2. Inspection and Installation	10
2.1 Packing List	10
2.2 Requirements of Power Supply	10
2.3 Operating Environment	11
2.4 Cleaning	11
2.5 Replace Battery	11
2.6 Replace Strap	11
2.7 Tilt Stand	12
3. Preparation before Measurement	13
3.1 Power on and Run	13
3.1.1 Power on and off	13
3.1.2 Introduction of Test Lead	13
3.1.3 Test Lead	13
3.1.4 Connection of Test Lead	13
3.2 Measurement Method of DUT	14
3.3 Set Zero and Calibration	15
3.3.1 Short-Circuit Test	15
4. [Test] Measurement Page	17
4.1 <Test>page	17
4.1.1 【Trigger】	17
4.1.2 【Function】	17
4.1.3 【R-Range】	18
4.1.4 【V-Range】	18

4.2 Save and View Data	19
4.3 Screenshot Function	19
5. [Utility] Setting	20
5.1 Parameters of Measurement	20
5.1.1 Timer	20
5.1.2 Beep.....	20
6. Comparator Sorting	21
6.1 Comparator Setting	21
6.1.1 Comparison Mode Selection	21
6.1.2 【nominal value】 set up	21
6.1.3 【Upper limit】 and 【Lower limit】 set up.....	21
6.2 Display and Determination	22
6.2.1 Display after Opening the Comparator	22
6.2.2 Example of Qualified Determination	23
6.2.3 Example of Unqualified Determination	23
7. System Configuration	24
7.1 System Configuration Settings	24
7.1.1 LANGUAGE Setting	24
7.1.2 DATE and TIME Setting	24
7.1.3 AUX SCREEN Setting.....	25
7.1.4 KEY BEEP Setting	25
7.1.5 BAUD Setting.....	25
7.1.6 BRIGHTNESS Setting.....	25
7.1.7 APO Setting	25
7.2 System Information.....	26
7.3 System Service.....	26
8. Technical Index	27
8.1 Technical Index of Product	27

1. Introduction

This chapter includes:

- ✚ Product Introduction
- ✚ Main function
- ✚ Front panel & Interface panel

1.1 Product Introduction

UT3550 battery internal tester, measured voltage range is 100V. See the below table, more specific technical index refer to the last chapter.

Model	Accuracy	Measurement Range
UT3550	Resistance: $\pm 0.5\%rdg \pm 5dgt$ Voltage: $\pm 0.05\%rdg \pm 5dgt$	Resistance: 0.001m Ω ~30.00 Ω Voltage: 0.0001~100.00V

Product Characteristics

UT3550 is all automated and real-time detection handheld instrument which made by high-performance 32 bit ARM microprocessor. This instrument can test resistance 0.001m Ω ~30.00 Ω and DC voltage 0.0001V~100.00V.

It has built-in USB-Type-C interface, through data collection software to remote control, collect and analyze data.

UT3550 use remote control instruction set and compatible with SCPI (Standard Command for Programmable Instrument) to fulfill remote control and data collection.

The AC resistance testing principle can be used for the internal resistance testing of almost all batteries, including lithium batteries, Hydrogen fuel batteries, lead-acid batteries, button batteries and other batteries. The design allows direct on-line measurement of the UPS without loss of accuracy and stability.

IP65 dustproof and waterproof, even in the dust pollution, splashing industrial site, can also help you to accurately measure.

1.2 Main Function

1.2.1 Calibration Function

Full-range short circuit zeroed function.

1.2.2 Comparator Function (sorting)

Built-in sorting data, estimate measured object by OK/NG.

- **Compare Method:**

ABS tolerance \pm TOL sorting: compared with the upper/lower value of measured value and absolute deviation value

PER tolerance %TOL sorting: compared with the upper/lower value of measured value and percentage deviation of nominal value

SEQ comparison sorting: measured value compared with the upper/lower value

- **Beep**

Beep can set OFF / OK / NG beep by user-defined.

1.3 System

1. Keypad lock function
2. Switch Chinese/English language
3. Date and time setup
4. Administrator and user account, administrator account can set code
5. Backlight setup
6. Auto power off time setup

1.3.1 Remote Control







Support maximum 115200bps baud rate, compatible with SCPI protocol, ASCII transmission.

1.4 Front Panel

1.4.1 Introduction of Front Panel

Front Panel	Number	Function
	1	3.5 inches LCD
	2	Function keys
	3	Power switch
	4	Test terminals
	5	Function short cuts
	6	Numeric keypad

Introduction of Symbol

Symbol	Description
	U disk inserts into instrument, it can save data and screenshot
	Key lock function enabled
	There is no measured value, measurement line and object does not connect
	It presents measured value is qualified within comparator range
	It presents measured value is not qualified with comparator range
	After setting up comparator, measured result is failed (unqualified)
	After setting up comparator, measured result is pass (qualified)

1.5 Interface Panel

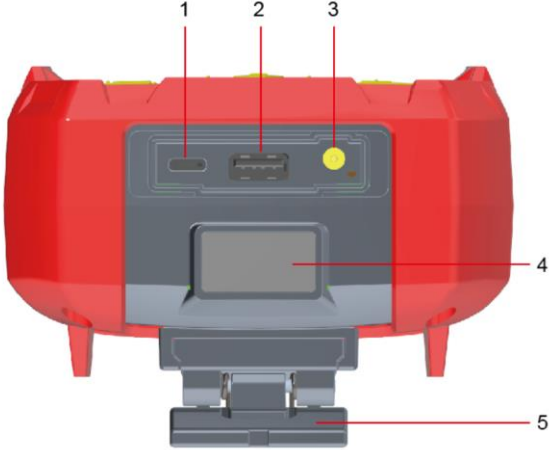
Top View	Number	Function
	1	Type-C interface
	2	USB interface
	3	Power Socket
	4	0.96 inches sub-display
	5	Replaceable clip

2. Inspection and Installation

2.1 Packing List

Before use:

1. Check whether product appearance is damaged, scratched or has other defects;
2. Check with packing list to confirm that accessories has no loss.

If there have any problem, please contact with Uni-Trend Instrument Sale Department or the distributor.

Components	Quantity	Remarks
Battery internal resistance tester	1	
Power adapter	1	
Soft carrying pouch	1	
Shoulder belt	1	
USB communication cable-Type-C	1	
Magnetic strap	1	
UT3550 kelvin clips wire	1	special for UT3550 battery tester
UT3550 test pen-crown probe	optional	optional, special for UT3550 battery tester
User Manual	1	electronic file, download from the official website

2.2 Requirements of Power Supply

It has standard power adapter for UT3550 battery internal resistance tester.

When connect with external power supply, the instrument will use external power supply and cell stop supply power automatically. External power supply also can charge up built-in lithium battery. It is suggested that use our company' s specialized power adapter.

Insert the power adapter into the AC input terminal on the instrument.

AC Power Adapter:

Input: 100V-240V, ~50Hz/60Hz, 0.6A Max

Output: 9V, 2000mA



Warning: It can not use other standard power adapter. **This instrument can only match with our company' s power adapter and recharge lithium battery!**

If battery capacity is not full, when insert power adapter the instrument enables charge up built-in lithium battery. When backlight of power switch light on yellow, it presents in-charging. The indicator light still light on after power off, it will be light on green when full charged.

2.3 Operating Environment

UT3550 series must be used under the following environmental conditions:

Temperature: 0°C ~ 40°C

Humidity: 10~80%RH

Altitude: 0~2000 meter

2.4 Cleaning

To prevent from the risk of electric shock, please pull out power line before cleaning.

Please use a clean cloth dipped in clean water to clean the cover and panel.

Do not clean the inside of the instrument.



Notes: Do not use solvents (alcohol or gasoline etc.) to clean the instrument.

2.5 Replace Battery

The instrument has built-in rechargeable lithium battery, the battery installed in cell barn.

If it need to replace battery, please do it as figure :

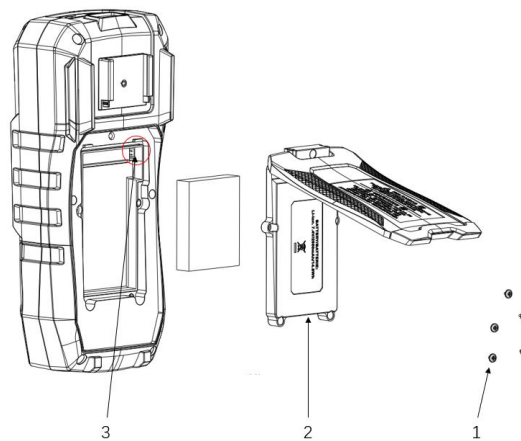

1. Take down screws
2. Open cell cover
3. Pull out built-in lithium battery

2.6 Replace Strap

Strap can replace or take down, please the following steps,

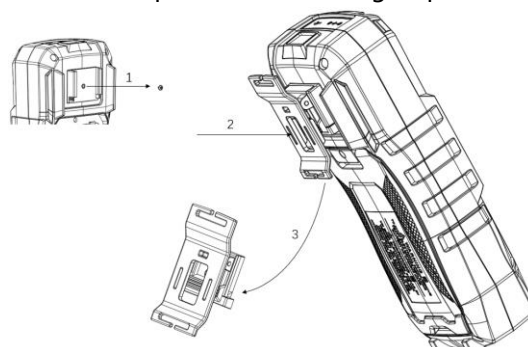

1. Take down screw
2. Push the strap
3. Push down and then pull out the strap

2.7 Tilt Stand

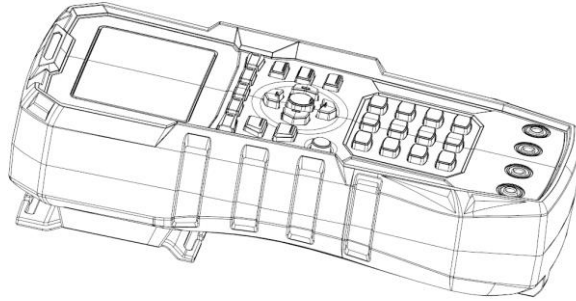

Figure 2-7-a Tilt Stand Closed Position

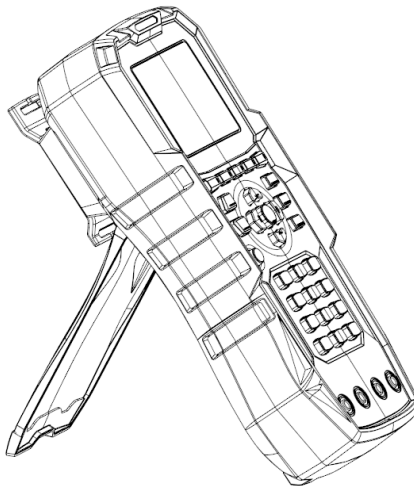



Figure 2-7-b Tilt Stand Open Position

3. Preparation before Measurement

3.1 Power on and Run

3.1.1 Power on and off

Turn on power switch , when indicator light display green (no power supply), it presents the power has been turn on.

3.1.2 Introduction of Test Lead

UT3550 series battery internal resistance tester is equipped with UT-L84 kalvin clips and UT-L86 test pen-crown probe, which is convenient for users to measure more professionally.

Figure 3-1-2 a UT-L84 Kalvin Clips Test Wire

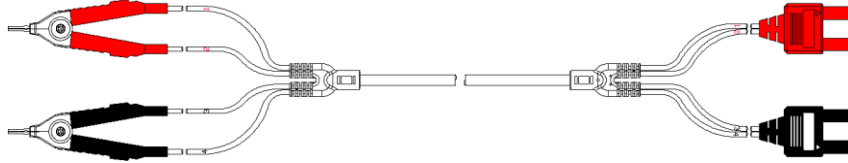
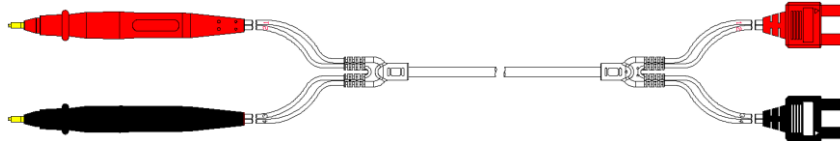

Figure 3-1-2 b UT-L86 Test Pen-Crown Probe



3.1.3 Test Lead

For the perspective of safety and test accuracy, it is recommended to use the standard test lead for measurement. The contact surface of test lead is gold plating, in the long-term work (1~2 year), it may cause plating abrasion, it is suggested that user to replace new test lead if test result appears deviation.

3.1.4 Connection of Test Lead

Before measurement, follow the steps below to connect the test lead to the test terminals of the instrument:

1. Before connecting the test line, please make sure that the power switch is OFF;
2. Make sure there is no connection at the top of the test leads of the four terminals;
3. Connect the test leads of the four terminals to the input terminals of the instrument according to the method shown in Figure 3-1-4, the steps as follows,

Connect the black test lead to the black terminal hole of the instrument and the red one to the red terminal hole.

The▲symbol of the black test lead must match the black SENSE hole on the front panel, and the▲ symbol of the red test lead must match the red SENSE hole.

The test lead must connect with terminal correctly, otherwise it may effect the output of test result.

Figure 3-1-4

Schematic Diagram of the Connection between the Test Lead and the Terminal Hole of the Instrument



Note: In order to ensure the accuracy of the instrument, please use the attached test lead for testing.

Warning: It is prohibited to connect the AC current and voltage source directly to the test terminals.

3.2 Measurement Method of DUT

After correctly connecting the test leads to the Sense and Source test terminals of the instrument, please connect the test leads to the DUT as follows. Note that the red test pen should be connected to the positive electrode of the battery, and the black test pen should be connected to the negative electrode. As shown in Figure 3-2-a.

If the positive and negative poles of the terminal of the DUT are connected reversely, and the test voltage value is negative, please exchange positions of the red and black test pen.

Figure 3-2-a Connect the Test Lead to the DUT



- When testing with an alligator clip, user can use the test lead to directly clamp the terminal of the DUT for four-terminal testing.
- If testing with a crown probe test pen, user can put the red and black test lead probes against the corresponding positive and negative terminals of the DUT for four-terminal testing, as shown in Figure 3-2-b.

Figure 3-2-b Schematic Diagram of Crown Probe Test Pen Measurement

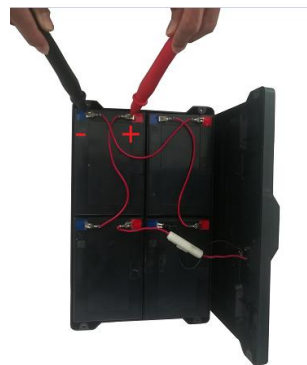

Note: When a negative voltage appears, it is caused by the reverse connection of the test leads, and the positions of the red and black test pen need to be changed.

3.3 Set Zero and Calibration

Before testing, please perform the short circuit zeroing step to remove the stray resistance and bias voltage caused by the test lead or external environment factors.

The measured resistance value may be very small, such as 3mΩ and 30mΩ range. When the test current flows through the resistance, the voltage signal generated will be very weak, and the maximum is only a few mV, so the position, length and shape of the test lead may all have effects on the measurement. Therefore, the positions and conditions during setting zero should be the same as those during subsequent measurement.

3.3.1 Short-Circuit Test

■ Method of Short Circuit Zeroed

- The first step** push 【Utility】 key to enter setup page
- The second step** short contact test pen
- The third step** use function key to select 【F4 SET ZERO】
- The fourth step** push 【F4 OK】 , the instrument start to zeroing
- The fifth step** When zeroing finished, go back to setup page

Short Circuit Zeroed Method of Kelvin Test Lead

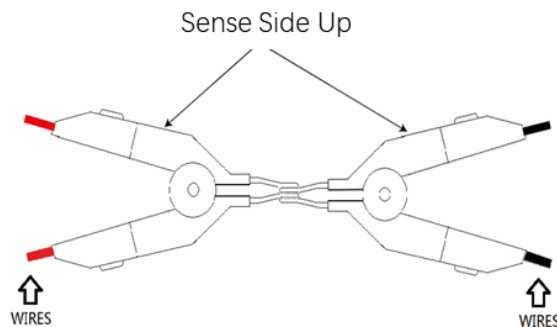

Correct Short Circuit Method of Crown Probe Test Pen

The center probe of the crown probe test pen is the Sense end, and the outer cylindrical probe is the Source end.

First, place the probes of the crown probe test pen as shown in Figure 3-3-1-a. Make sure that the surface of the object at the red dot is in contact, that is, the center probe is in contact with the center probe (Sense and Sense). And the center probe is in contact with the peripheral probe (Sense and Source).

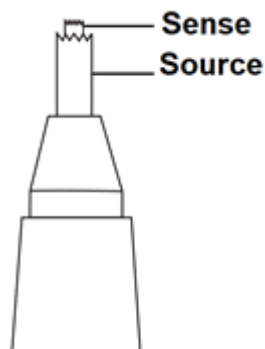

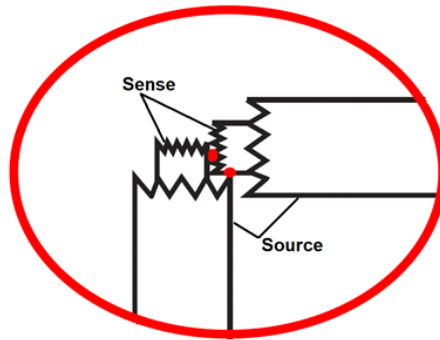

Figure 3-3-1-a Crown Probe Test Pen Short Circuit Diagram a

Second, apply force in the direction of the arrow shown in Figure 3-3-1-b to make the surface of the object at the third red point contact, that is, the periphery probe is in contact with the peripheral probe (Source and Source).

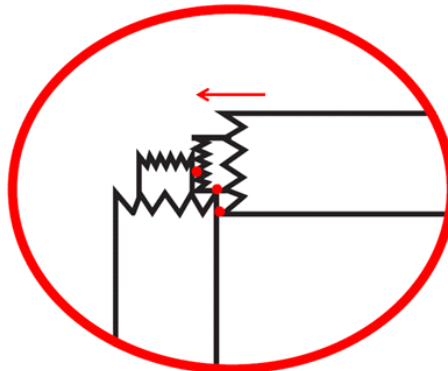

Figure 3-3-1-a Crown Probe Test Pen Short Circuit Diagram b

Finally, only when the three red dots as shown above are actually touched, the next setting zero step can be performed.

4. [Test] Measurement Page

4.1 <Test> page

<Test> page is mainly used to display the measurement and sorting results. Three common functions can be set on this page, including:

- TRIGGER - The Trigger Mode of the Measurement
- FUNC – Parameters of Measurement
- RANGE – Setting and Display of Resistance and Voltage Range

Figure 4-1<Test> Page



4.1.1 [Trigger]

The instrument has 2 trigger modes: internal trigger and external trigger (including manual /remote)

Function	Description
INT	Also called continuous test, the trigger signal is continuously tested by the internal of the instrument according to inherent cycle. Generally choose this method for measurement
EXT	Maunal: Each time press the [Trigger] key, the instrument will execute a measurement cycle, and the instrument is in a waiting state at other times.
	Remote: Send the command TRIGGER to measure once and return the measured value.

Setting Steps

1. Press [Test] key to enter the main page of <Test>;
2. Use the cursor key ▼ to move the cursor to the [TRIGGER] field;
3. According to user' s needs, use the function keys at the bottom of the screen to select the desired trigger mode.

4.1.2 [Function]

The instrument has 3 measurement functions: RV, R and V.

Function	Description
RV	Measure and display resistance and voltage values at the same time
R	Only measure and display the resistance value
V	Only measure and display the voltage value

Setting Steps

1. Press [Test] key to enter the main page of <Test>;
2. Use the cursor key ▼ to move the cursor to the [FUNC] field;
3. According to user' s needs, use the function keys at the bottom of the screen to select the desired measurement items.

4.1.3 【R-Range】

UT3550 series battery internal resistance tester has 5 ranges, it divided into manual and automatic mode, as shown in the following Table 4-1-2,

Table 4-1-2 Range Selection Method and Variation Range

Range Mode		Description
AUTO		The instrument automatically selects the corresponding best test range.
MANUAL		The instrument will always use the user-specified range for testing.
Manual Range	Automatic Range	Range
<4>30Ω	<4> AUTO	3Ω ~ 30Ω
<3>3Ω	<3> AUTO	300mΩ ~ 3Ω
<2>300mΩ	<2> AUTO	30mΩ ~ 300mΩ
<1>30mΩ	<1> AUTO	3.0mΩ ~ 30mΩ
<0>3mΩ	<0> AUTO	0.001mΩ ~ 3mΩ

Setting Steps

1. Press **【Test】** key to enter the <test>page or press **【Utility】** key to enter the <setup> page;
2. Use the cursor key ▼ to move cursor to the **【R-RANGE】** field;
3. According to user' s needs, use the function keys at the bottom of the screen to select the desired range method and range. If user select AUTO, the instrument will automatically select the corresponding best test range and range; if user select MANUAL, the instrument will always use the user-specified range for testing; INC+ means increase the range, while the range is changed to lock; DEC- means decrease the range, and the range is changed to lock at the same time.



When the range is automatic, the instrument will predict the range in each measurement period, so the test speed will be slightly slower than the locked range. Moreover, in the case of automatic measurement, frequently changing the range will slow down the response. Usually when the instrument is used as a sorting measurement, the automatic range mode is not suitable. For sorting measurement, it is recommended to select manual range mode.

4.1.4 【V-Range】

Voltage range setting: UT3550 series battery internal resistance tester has 3 ranges and two ranges selection modes: automatic and maunal

Table 4-1-4 Range Selection Mode and Variation Range

Range Mode		Description
AUTO		The instrument automatically selects the corresponding best test range.
MANUAL		The instrument will always use the user-specified range for testing.
Manual Range	Automatic Range	Range
<1>100V	<1> AUTO	10~100V
<0>10V	<0> AUTO	0.0001~10 V

Setting Steps

1. Press **【Test】** key to enter the <test>page or press **【Utility】** key to enter the <setup> page;
2. Use the cursor key ▼ to move the cursor to the **【V-RANGE】** field;
3. Accorsing to user' s needs, use the function keys at the bottom of the screen to select AUTO, MANUAL, INC+ or DEC-.



When the measured value exceeds the setting range, OL is displayed on the test interface.
When the range is automatic, the instrument will make range prediction at each measurement

period, so the test speed may be lower than locking range; In addition, in the automatic measurement, change range frequently will lead to slow response.

When the instrument at sorting measurement, automatic mode is not suitable. For sorting, it is suggested to select manual mode.

If measured value exceed the setting range, test interface display OL; if the test circuit is open fully, test interface display -----

4.2 Save and View Data

The measured display value can be manually saved (up to 500 sets of data can be stored) and quickly browsed on the instrument screen. Press the function key [SAVE DATA] at the bottom of the screen to manually save the data. Each time user press the key, the data will saved manually. Via the function key [VIEW DATA], user can view the manually saved measurement data on the instrument screen, as shown in Figure 4-2

Figure 4-2 <View DATA> Page

16:04				
<VIEW DATA> RES UNIT AUTO				
No.	AC-R(Ω)	DC-V(V)	DATE-TIME	PAGE 24
231	30.26 m	+0.0000	2021-09-08 23:42:58	
232	30.21 m	-0.0001	2021-09-08 23:43:58	
233	30.18 m	-0.0001	2021-09-08 23:44:58	
234	30.22 m	-0.0001	2021-09-08 23:45:58	
235	30.14 m	-0.0001	2021-09-08 23:46:58	
236	29.97 m	-0.0001	2021-09-08 23:47:58	
237	29.84 m	-0.0001	2021-09-08 23:48:58	
238	29.79 m	-0.0002	2021-09-08 23:49:58	
239	29.70 m	-0.0001	2021-09-08 23:50:58	
240	29.63 m	-0.0001	2021-09-08 23:51:58	

SAVE TO USB DISK	CLEAR	JUMP TO	PAGE UP	PAGE DOWN
---------------------	-------	------------	------------	--------------

On the <VIEW DATA> page, user can also use the function keys at the bottom of the screen to perform the following operations on the data,

- Save to USB disk: after inserting the U disk, this function key can save the data in the U disk.
- Clear: this function key can clear all data.
- Page Up/ Page down/ Jump to: this function key can realize the page up and down or jump of multiple pages of data.

If user want to delete a row of data, you can press the arrow keys to stop the cursor on a specific row, and select the [DELETE] function key at the bottom of the screen to delete this row of data.

4.3 Screenshot Function

The instrument provides a screenshot function, insert a USB storage device into the USBinterface on the front panel, press [ENTER] key to save the current screen capture to the USB disk for subsequent reference.



If user need to save data, it is recommended to use a branded U disk to insert the instrument interface. The format and capacity can refer to FAT, FAT32, EXFAT.

When the data is being collected, it may cause the screen capture to fail, which can be executed after the collection is completed.

5. [Utility] Setting

5.1 Parameters of Measurement

All the settings related to the measurement are operated on the <TEST> page. [TRIGGER], [FUNC], [R-RANGE], [V-RANGE] can also be set on the <TEST> page. For the setting of these parameters, please refer to chapter 4.1 [Test] Measurement Page.

The rest of the settings include the following parameters,

- Timer – delayed before measurement of external trigger
- Beep – beep alarm

Figure 5-1 <SETUP> Page

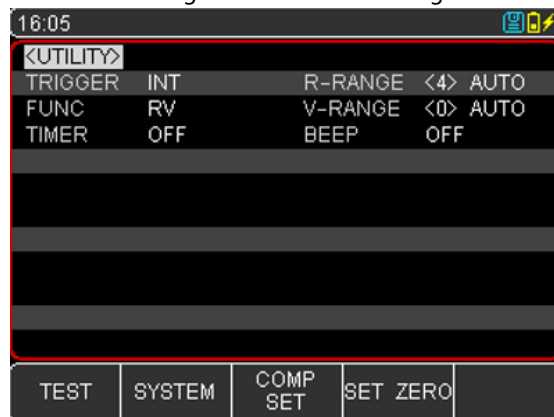

5.1.1 Timer

In order to conveniently collect data into internal storage, user can use Timer collect function. When test is ready, the instrument will start timer, when it count to 0, it will keep the current data into internal storage.

User can view the collected data in <VIEW DATA> page.

Setting Steps of Timer

1. press [Utility] key to enter setup page;
2. Use the cursor to select [Timer] filed;
3. Use numeric keypad to enter time, unit is second.

5.1.2 Beep

The beep function is effective only when comparator function is turned on.

Beep function has three settings: OK (qualified beep), NG (unqualified beep) and OFF (turn off beep).

OK: the buzzer will sound when the sorting result is qualified

NG: the buzzer will sound when the sorting result is unqualified

Setting steps

1. Press [Test] or [Utility] key, and select [COMP SET] with the function key at the bottom of the screen to enter [COMP SET] page;
2. Use the cursor key move the cursor to the [Beep] filed;
3. According to user' s needs, use the function keys at the bottom of the screen to select OK, NG and OFF.

6. Comparator Sorting

6.1 Comparator Setting

Figure 6-1 <COMP SET> Page

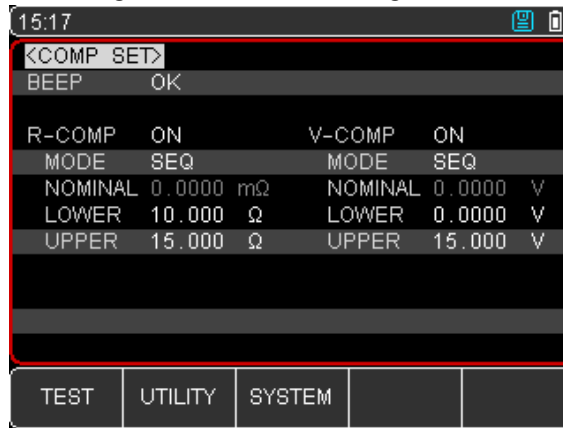

6.1.1 Comparison Mode Selection

The instrument can compare resistance and voltage simultaneously or separately. There are 3 comparison modes to choose from:

- Absolute Value Comparison ABS (Δ): Absolute Value $\Delta = \text{Measured Value} - \text{Nominal Value}$
- Percentage Comparison PER ($\Delta\%$): Percentage $\Delta\% = (\text{Measured Value} - \text{Nominal Value}) / \text{Nominal Value} \times 100\%$
- Direct-Reading Comparison (SEQ): The direct-reading value SEQ comparison uses the direct-reading measurement value to compare with the upper and lower limit ranges, so the nominal value is not required to participate in the calculation.

6.1.2 【nominal value】 set up

The absolute value and percentage comparison mode must enter the nominal value. As for direct reading comparison mode, the nominal value does not participate in calculation.

Setting Steps for Absolute Value Comparison ABS (Δ) or Percentage Comparison PER ($\Delta\%$)

- Press **【Test】** or **【Utility】** key, and select **【COMP SET】** with the function key at the bottom of the screen to enter **【COMP SET】** page;
- Use the cursor to the **【R-COMP】** or **【V-COMP】** field to select ON;
- Move cursor move to **【Mode】** field, and select comparison mode absolute value or percentage;
- After operating the third step, move cursor to the corresponding**【nominal value】**,**【Upper limit】** or **【Lower limit】** field, use numeric keyboard to enter data, unit set by functional key.

6.1.3 【Upper limit】 and 【Lower limit】 set up

Setting Steps for Direct-Reading Comparison SEQ

- Press **【Test】** or **【Utility】** key, and select **【COMP SET】** with the function key at the bottom of the screen to enter **【COMP SET】** page;

2. Use the cursor to the **【R-COMP】** or **【V-COMP】** field to select ON;
3. Move cursor move to **【Mode】** field, and select absolut value;
4. After operating the third step, move cursor to the corresponding **【Upper limit】** or **【Lower limit】** field, use numeric keyboard to enter data, unit set by functional key.

Notice: Percentage mode $\Delta\%$ does not need to select unit ratio, enter percentage value; absolute valu Δ and direct reading SEQ mode need use functional key to select unit.



The instrument shares the same storage space for the three comparison modes, so the comparator data needs to be reset after switching the comparison mode.

6.2 Display and Determination

6.2.1 Display after Opening the Comparator

When the comparator setting is completed, press **【Test】** to enter the main page of <TEST> ,as shown in Figure 6-2-1.

Figure 6-2-1 Page to Be Measured after the Comparator is Turned on

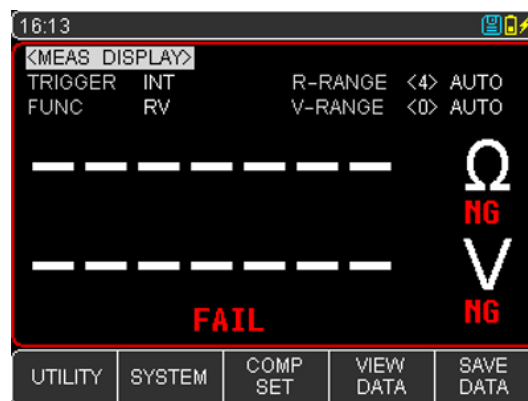

- After the comparator is turned on, the “COMP” logo will appear at the top of the screen, which means that the comparator function has been turned on at this time. The determinating symbol **NG** **FAIL** is displayed on the screen, which is a normal interface.
- “**-----**” means that the test clip or test pen is not properly connected to the object under test. Please connect the test clip or test pen to the object under test correctly to enter the state to be measured.

6.2.2 Example of Qualified Determination

Figure 6-2-2 Example of Qualified Determination Page

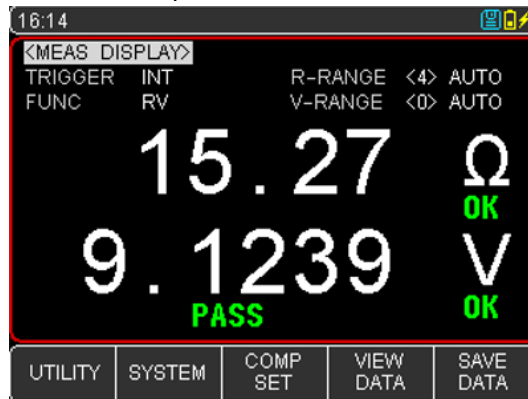

- When the voltage or resistance measurement value is within the setting range of the comparator, the judgment symbol **OK** of the test value will be displayed on the screen, indicating that the measured value is within the specification range. Only when the resistance and voltage are within the range, the instrument will judge the total result of this group of test data as qualified, and a qualified mark **PASS** will appear on the screen.
- If the buzzer is set to “beep when qualified” at this time, the instrument will emit a qualified buzzer for the qualified situation.
- If the buzzer setting is OFF at this time, there will be no buzzer sound.

6.2.3 Example of Unqualified Determination

Figure 6-2-3 Example of Unqualified Determination

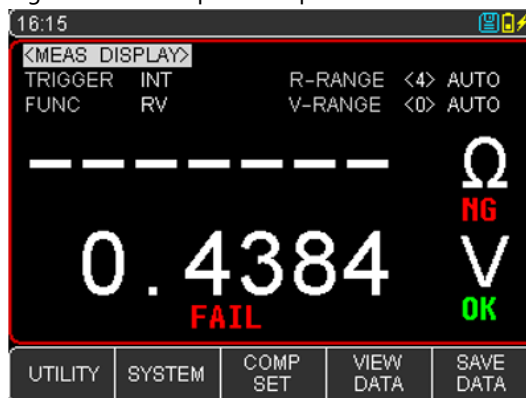

- When the voltage or resistance measurement value exceeds or falls below the comparator setting value, in any of these situations, the instrument determines that the test result is unqualified, the symbol is **FAIL**.
- If the buzzer is set to “beep when unqualified” at this time, the instrument will emit a unqualified buzzer for this situation.
- If the buzzer setting is OFF at this time, there will be no buzzer sound.

7. System Configuration

7.1 System Configuration Settings

<SYSTEM CONFIG> page mainly includes system configurations such as language, data, time, key beep, remote control, and default setting.

At any time, just press **【Test】** or **【Utility】** key, and the **【SYSTEM CONFIG】** will appear at the bottom of the screen, press the corresponding function key can enter the <SYSTEM CONFIG> page.

All settings on the system configuration page will be automatically saved in the system and loaded automatically when the system is turned on next time.

Figure 7-1 < SYSTEM CONFIG > Page

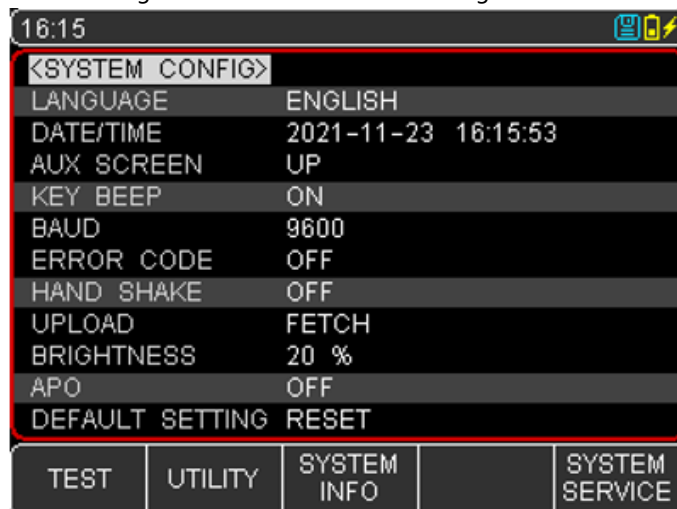

7.1.1 LANGUAGE Setting

The instrument supports two languages, Chinese and English.

Setting Steps

1. Press **【Test】** or **【Utility】** key, and select **【SYSTEM】** with the function key at the bottom of the screen to enter the < SYSTEM CONFIG> page;
2. Use the cursor key to move the cursor to **【LANGUAGE】** ;
3. According to user' s needs, press the function key at the bottom of the screen to select Chinese [CHN] or ENGLISH (English).

7.1.2 DATE and TIME Setting

The instrument uses a 24-hour clock, and it can modify the date and time.

Setting Steps

1. Press **【Test】** or **【Utility】** key, and select **【SYSTEM】** with the function key at the bottom of the screen to enter the <SYSTEM CONFIG> page;
2. Use the cursor key to move the cursor to the [DATE] or [TIME] field;
3. According to user' s needs, press the function key at the bottom of the screen to select the

year, month, day, hour, minute and second that you want to set.

+ means the value plus 1 and – means the value minus 1. For example, year+, month+, day+, hour+, minute+, and second+ represent +1 year, +1 month, +1 hour, +1 minute, and +1 second respectively and vice versa.

7.1.3 AUX SCREEN Setting

Sub-screen has three settings: OFF/ UP/ DOWN

1. Press **【Test】** or **【Utility】** key, and select **【SYSTEM】** to enter < SYSTEM CONFIG > page;
2. Use the cursor key to move the cursor to **【AUX SCREEN】** field;
3. According to user' s needs, press the function key at the bottom of the screen to select OFF, UP and DOWN.

7.1.4 KEY BEEP Setting

The instrument key can set with or without key prompt sound.

Setting Steps

1. Press **【Test】** or **【Utility】** key, and select **【SYSTEM】** to enter < SYSTEM CONFIG > page;
2. Use the cursor key to move the cursor to **【KEY BEEP】** field;
3. According to user' s needs, press the function key at the bottom of the screen to select ON or OFF. ON means that the key beep is on; OFF means that the key beep is off.

7.1.5 BAUD Setting

The instrument has built-in Type-C interface, after the instrument senses the signal conversion of the Type-C interface, it immediately communicates with the host at the set baud rate and the keyboard is locked.

In order to communicate correctly, it is necessary to confirm whether the baud is set correctly, otherwise the upper computer cannot communicate correctly.

The instrument with Type-C use SCPI language to programming.

Setting Steps

1. Press **【Test】** or **【Utility】** key, and select **【SYSTEM】** to enter < SYSTEM CONFIG > page;
2. Use the cursor key to move the cursor to **【BAUD】** field;
3. According to use' s needs, press the function key at the bottom of the screen to select differen baud rates, 9600, 19200, 38400, 57600, 115200.
4. To communicate with the host computer, it is recommended to use 115200 high-speed baud rates.

7.1.6 BRIGHTNESS Setting

The more the brightness is darker, the more the power consumption is lesser, and the instrument operating time will be longer. The instrument can set 5 brightness level to meets different light needs.

Setting Steps

1. Press **【Test】** or **【Utility】** key to enter the main page;
2. Select **【SYSTEM】** key to enter <SYSTEM CONFIG>;
3. Use the cursor key to move the cursor to **【BRIGHTNESS】** field;
4. Use the function key to select brightness level.

7.1.7 APO Setting

When the test measurement valus is exceed range, no operating, serial port pause to respond and reach to auto power off time, the instrument will save the data and turn off automatically.

Setting Steps

1. Press **【Test】** or **【Utility】** key to enter the main page;
2. Select **【SYSTEM】** key to enter <SYSTEM CONFIG>;
3. Use the cursor key to move the cursor to <APO> filed;
4. Use the function key to select auto power off time.

Function key	Description
5 minute	
15 minute	The default value to save power
30 minute	
60 minute	
OFF	

7.2 System Information

Press the [Test] or [Utility] key, and select [SYSTEM] with the function key at the bottom of the screen to enter the <SYSTEM CONFIG>page; press the function key to select [SYSTEM]. This part contains the model, the serial NO. and FW version.

This page does not require the user to set up.

7.3 System Service

Press the [Test] or [Utility] key, and select [SYSTEM] with the function key at the bottom of the screen to enter the <SYSTEM CONFIG>page; press the function key to select [SYSTEM SERVICE].

Warning: This page is not open to users. It is used to calibrate data when leaving the factory. Non-professionals cannot enter by force. Otherwise, the calibration data may be lost, resulting in a large deviation of the measurement data.

8. Technical Index

8.1 Technical Index of Product

Figure 8-1 Technical Index

Function	Range No.	Range	Resolution	Accuracy	Measuring current	Description
Resistance Measurement	0	3mΩ	1μΩ	±0.5%rdg. ±5dgt	150mA	Measuring current frequency: 1kHz±30Hz
	1	30mΩ	10μΩ		150mA	
	2	300mΩ	100μΩ		15mA	
	3	3Ω	1mΩ		1.5mA	
	4	30Ω	10mΩ		150uA	
Voltage Measurement	Range name	Range	Resolution		Accuracy	Description
	0	10V	100μV		±0.05%rdg. ±5dgt	/
	1	100V	1mV			
Display			3.5 inch LCD display +0.96 inch OLED on the top			
Range Mode			Auto and Manual (resistance and voltage)			
Calibration			Short circuit full range to zeroed			
Testing Speed			1/s (manual range)			
Sorting Function			It has three output situations: exceed resistance and voltage upper limit/ exceed resistance and voltage low limit and conform Sorting result has two output situations: PASS and FAIL			
Beep			OFF, OK, NG			
Comparison Mode			Absolute deviation (ABS) , relative deviation (PER) Direct-reading (SEQ)			
Other Function			Lock keypad, U disk storage, keypad tone, Chines/English language, screenshot			
Test Terminal			Four-terminal test method			
Trigger			Internal, manual and remote			
Storge			The maximum storge is 500 groups, support USB to copy data			
Interface			Type-C interface(communication), USB interface(storage), Charging interface			
Upper-computer Software			SCPI			
Charging Time			<5 hour			
Operating Time			About 5 hour (20% brightness display)			
Power			The maximum 5VA			
Power Supply			7.4V , 2000mAh rechargeable lithium battery or 9VDC 2A power adapter			
Preheating Time			At least 15 minute			
Temperature/Humidity Index			Temperature: 18°C~28°C, Humidity: <65%RH			
Operating Temperature/Humidity			Temperature: 0°C~40°C, Humidity: 10~80%RH			
Storage Temperature/Humidity			Temperature: -20°C~60°C, Humidity: 10~90%RH			

Temperature Index	Over 28°C, less 18°C, each degree plus 0.1* the specified precision
Accuracy guarantee time	12 months
Operating Altitude	≤2000m

UNI-T[®]**UNI-TREND TECHNOLOGY (CHINA) CO., LTD.**

No.6, Gong Ye Bei 1st Road,
Songshan Lake National High-Tech Industrial
Development Zone, Dongguan City,
Guangdong Province, China